

# Design of Water PH Quality Monitoring System in PT SIER Industrial Area Based on Internet of Things at Waste Water Treatment Plant

Fajar Mei Dialaksito<sup>1</sup>, Pressa Perdana S.<sup>2</sup>  
Electrical Engineering Department  
Muhammadiyah Gresik University, Gresik, East Java, Indonesia  
fajarmeidialaksito97@gmail.com<sup>1</sup>, pressa@umg.ac.id<sup>2</sup>

Received: May, 20 2023

Accepted: June 25, 2023

Published: June 26, 2023

## ABSTRACT

PT SIER's Waste Water Treatment Plant manages industrial and domestic wastewater obtained from industrial activities in the PT SIER Industrial area. Waste Water Treatment Plant PT SIER has been established since 1980. Over time, growth and development industry is increasing so that it adds to the WWTP burden. With respect to the load the more heavy so need in take note a number of matter following among them Waste fluid contaminated products from the manufacturing process must be treated and controlled for its pH content, the volume of waste water to be treated, the quality of water resulting from the Waste Water Treatment Plant process Which expected, convenience in matter management water waste, energy sources, as well as costs low process operation. This study aims to cut the process of taking sample water waste until analysis laboratory to get results monitoring quality pH water. On this study the writer make system monitoring quality pH water in areaindustry PT. SEER based *Internet of Things* on waste water treatment Plant. Withutilizing ESP32 which is integrated by the Internet of Things (IOT) via the internet network from Wi-Fi routers. Results quality monitoring data water can be seen in realtime passes appearance mark pH, mark TDS And mark Temperature which accessed through smartphones nor PC so thatmark water quality delivered to the Blynk app.

**Keywords:** Waste, WWTP, Monitoring quality water, ESP32, pH, TDS, Temperature, *Internet of Things* ,Application Blynk

## 1. INTRODUCTION

Industrial activity that continues to run will provide products that can meet the needs need life man, However in activity production they have material outcast which is called Waste, Where waste the must done treatments especially formerlybefore being discharged into the environment. Wastewater or liquid waste is one type of waste Which Lots generated in activity industry. kindly normative center government hasregulates the processing of liquid waste, including the Regulation of the Minister of Environment No.5 of 2014 concerning Wastewater Quality Standards and East Java Governor Regulation No. 72Year 2013 about raw Quality Shared Wastewater Industry and/or Activity Business Other.

The development of information technology continues to play a role in encouraging humans to do things activities The benefits of the development of information technology can make it easier for humans in obtain information Which more efficient And accurate. Development technology informationNo will succeed without there is innovation from man to manage and take care of him well. Progress technology here it is Which require company For Keep going follow development technology And innovate in take advantage technology information in manage various data and information more efficiently and accurately. But if the companynot following the flow of technology will have many negative impacts that will be created. Like experience material loss nor abandoned Report Company.

In today's era of globalization, information technology plays a very important role fulfil all need Business Company, from facet production, supervision, oranalysis. With exists technology information make it easy company in promotecompany excellence and promote the excellence of its products. Information Technology

very role in do analysis process company That Alone. And can make it easy and accelerate inside get result information analysis process.

The system created is also integrated with the Blynk android application to make it easier user in monitoring quality water because application Blynk own appearance which interactive and *user friendly*. Implementation system on application Blynk Also easy because enough *drag and drop* for change appearance or buttons on application Blynk. Monitoring which is used on this research is real-time monitoring in a manner No direct.

The researcher used the ESP32 microcontroller as the data processing center for the results reading sensors pH, TDS and Temperature For in measuring level quality water and sent to application Androids. The ESP32 microcontroller was chosen because of several factors such as, ESP32 has a price which affordable, ESP32 Already integrated with module Wi-Fi which needed for connection with internet. Another reason is that some of the sensors used are sensors analog and on the ESP32 there are sufficient ADC (Analog to Digital Converter) pins need sensors the.

Waste water treatment Plant Not yet fully apply technology information based Internet Of things, so that writer pushed to do study create an innovation to make it easy process management water waste industry area at PT. SER

## 2. RESEARCH METHODOLOGY

Design, method, or approach used to answer research questions and reach objective study discussed in chapter this. Explanation covers parameter research, the model used, research design, methods of obtaining data, data analysis And theory Which used to implement study.

Diagram flow on Picture describe development methodology settlement task:

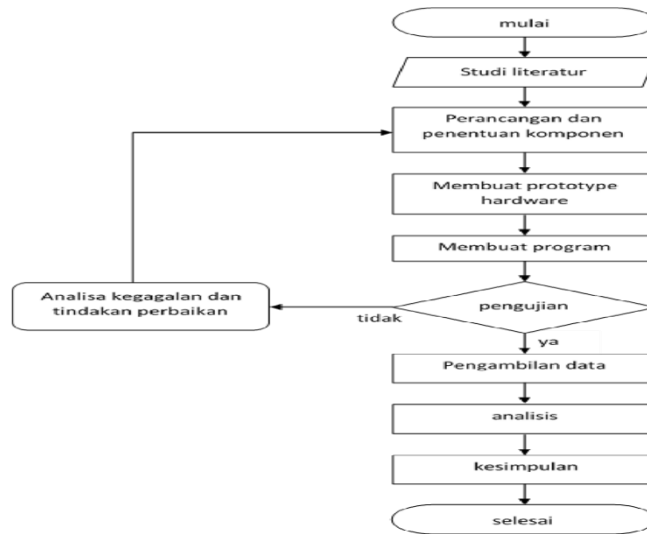

Picture 1. Flow Charts Settlement Task End

### A. Studies Literature

The first step in the research method is a literature review, which involves information search about the research component in publications, online resources, and books. The results of discussions and consultations with lecturers or experts in this field become source direct. This research literature is :

- Monitoring quality water in area industry PT. SEER
- ESP32, sensor, TDS sensors and Temperature Sensors
- Internet of Things* (IoT)

### B. Design System

At this stage, the design of the ESP Microcontroller Implementation system will be carried out 32 for Monitoring Water Quality in the PT.SIER Industrial Estate on Waste Water Internet of Things-based Treatment Plant. System block diagram design aims For give description about tool Which designed by writer Which started from source sensors pH, sensors TDS And sensors Temperature Then connected to

microcontroller ESP 32 with step Down use cable jumpers, microcontroller ESP 32 connected to the server wirelessly, then the server and client are connected to the insidenetwork Which available. For more he explained Can look at picture below:

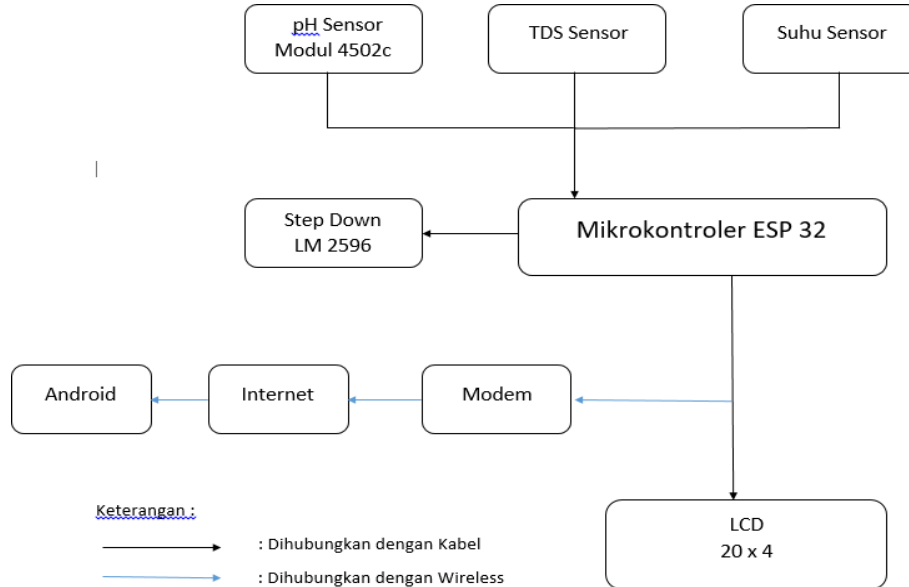

Picture 2. System Block Diagram

### C. Design system planning

Information Design system planning analysis quality water in a manner realtime Which then it will be channeled to the pH sensor, TDS sensor and temperature sensor. pH sensor module as a sensor that functions to read the pH of water, the TDS sensor module as a sensor function measure particle dissolved in water And module sensors Temperature as sensors Which function For change temperature / Temperature become different potential electricity. ESP32 become center control data Which has filled program For controller device system security, Routers as liaison between ESP32, servers And client, routers Also function give IP to each device, servers as media data storage of monitoring results of pH values, TDS values and temperature values, Client as computer or gadgets Which will used user For displays results mark Set Point.

### D. Design hardware

Design system Hardware use Microcontroller ESP 32 For Monitoring water quality in the PT.SIER Industrial Estate in Waste Water Treatment Plant based Internet of Things. Draft system hardware aim For provide an overview of the designed tool by the author starting from source sensors pH, sensors TDS And sensors Temperature Then connected to microcontroller ESP 32. next is a design hardware Which used that is :

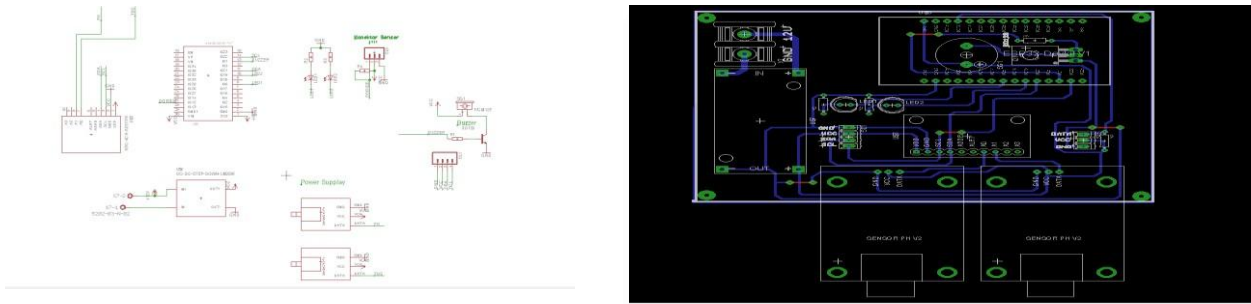

Picture 3. Hardware Design

ESP32 as microcontroller Which introduced by expressive System is successor from microcontroller ESP8266. On microcontroller This Already available module WiFi in the chips so that very support For make system application Internet of Things (IOT).

sensors pH as device Which can used For measure degrees acidity or the basicity of the solution.

sensors Total Dissolved Solids as device electronics Which used For measure dissolved particles in water, dissolved particles including organic and inorganic substances. TDS (Total Dissolved Solid) itself uses the level of solid object concentration dissolved in water.

The DS18B20 Temperature Sensor functions to change the amount of heat captured become voltage magnitude.

LCD as an electronic element that shows character data or graphics on the screen electronic.

### E. Planning Software

Design software that is tell about channel Work tool And writer use flow chart For decipher process system monitoring quality water in area PT. SIER industry on Wastewater treatment Plants :

#### 1) Design Process

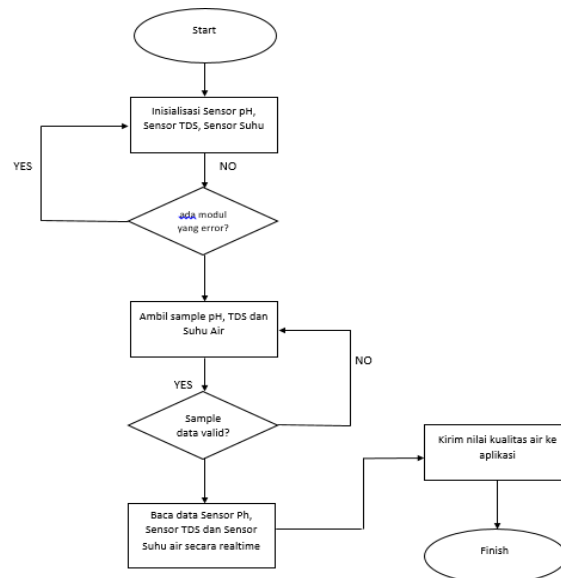

Picture 4. Flow chart system monitoring

#### 2) Design Architecture System

Following is design system on system monitoring Quality water use application Blynk

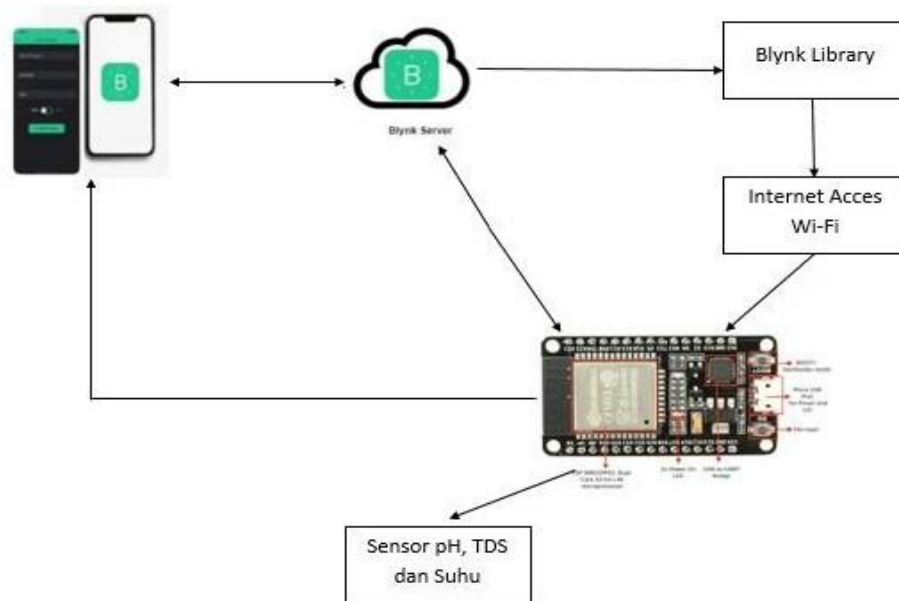

Picture 5. Design Architecture Application Blynk

### 3) Design Design Tool

The hardware design shown in Figure 3.5 uses three units sensor, one unit of ESP32.LCD 20x4 microcontroller and Step Down LM2596. Part second is sensors Which can placed in shelter water waste. Sensors connected on component part First use cable. Whereas ESP32 is Brain main from system monitoring quality water there isvarious sensors like sensors pH, sensors TDS, And sensors temperature. There is Also Step Down component which functions to reduce the voltage from 12 volts to 5 volt. With the results of water quality monitoring data can be seen in real time via LCD on Display of pH value, TDS value and temperature value.

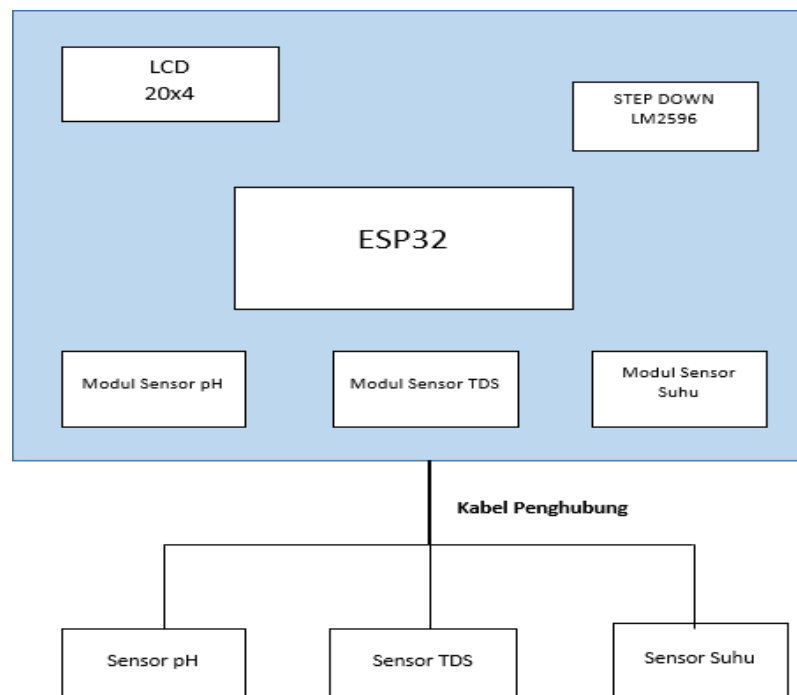

Picture 6. Design Design Tool

### 3. Results And Discussion

#### A. Implementation

Step For build between advance user system monitoring use application android Blynk, that is :

- 1) Downloads and Install application Blynk through “play store”.
- 2) Open application Blynk carry on sign up new accounts or login If Already own account. Appearance early on Blynk gets shown on Picture 7.



Picture 7. Appearance Beginning on Blynk

- 3) Create a new project, then name it "Just try it" then choose device “Arduino Uno” connection type “WiFi” then click create. Steps how to make new project can be shown on Picture 8.

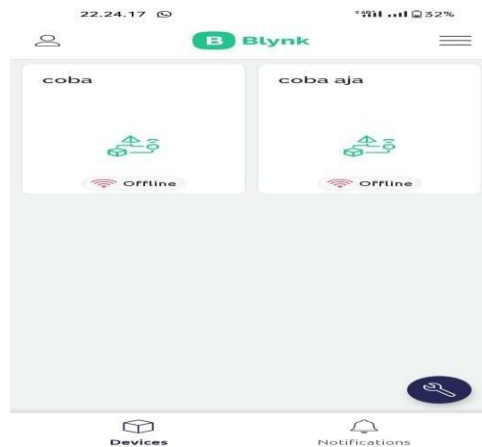

Picture 8. Making New Project

- 4) After that, create a new project, continue to get the auth token used so that existing project on Blynk can recognize the microcontroller used for build a quality monitoring system for temperature, TDS quality and water pH quality in PT. SEER on waste water Treatment Plant. Welcome to Blynk sent via email used for Create Password and can be shown on Figure 9.

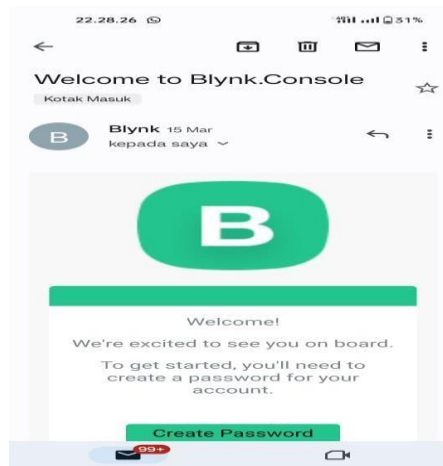

Picture 9. Message welcome to Blynk on Gmail

- 5) Add Value Displays Settings For displays monitoring data from sensors pH, click Value Display Settings on input type select advanced on select virtual pin V0 and can be shown on Figure 10.



Picture 10. Output pins V0 on pH sensors

- 6) then add Value Displays Settings Again For displays monitoring data from the Temperature sensor, click Value Display Settings then on input type select advanced And on virtual pin select V1. Can be shown on Picture 11.

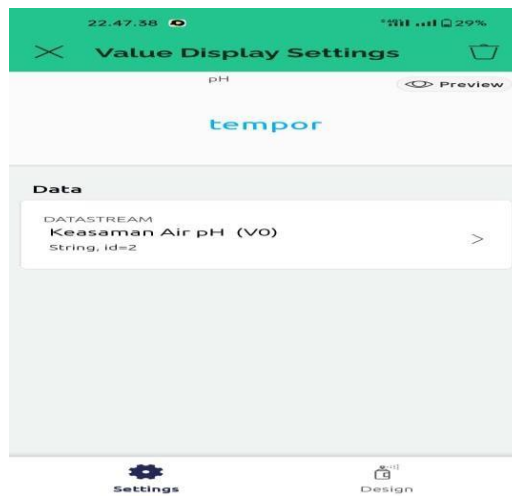

Picture 11. Outputs pin V1 on sensors Temperature

- 7) After that add Value Display Settings again to display monitoring data from the TDS sensor click Value Display Settings then on input type select advanced and on virtual pin select V1. Shown on Picture 12.

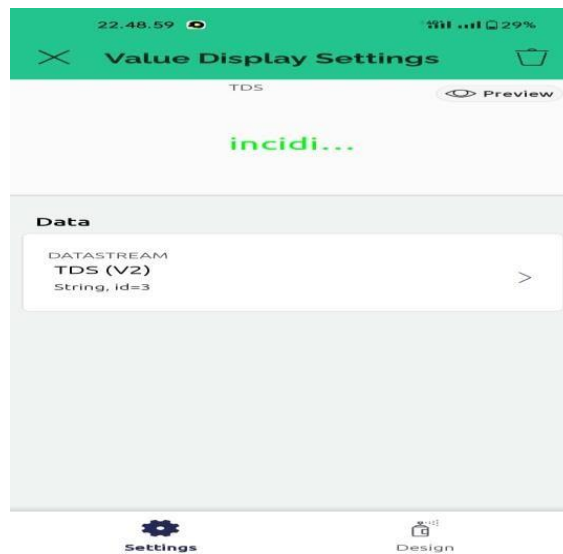

Picture 12. Out Pin V2 on sensors TDS

- 8) After all fake has added on application Blynk. will like onPicture 11.





Picture 11. Appearance monitoring interface on application Blynk

### B. Design get up tool

Stage beginning test get up tool that is make programming especially formerly use application arduino IDEA Which connect between ESP32 and Application Blynk .

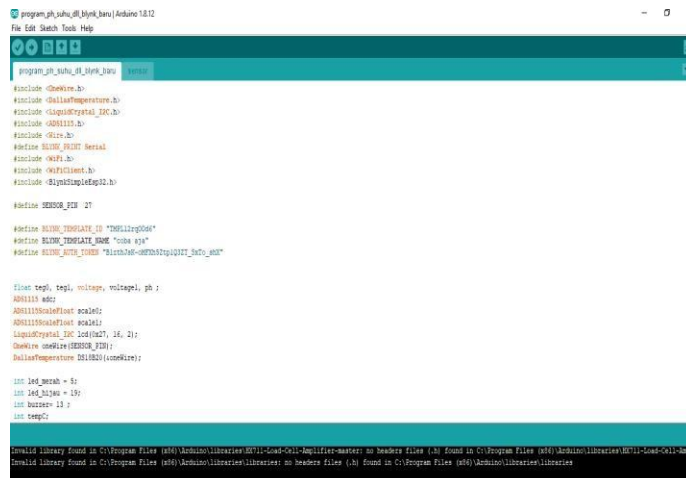

Picture 13. Program pH, TDS And Temperature on Application Blynk



Picture 14. Program IDEA sensors pH, TDS And temperature \

Tool design is done by knowing the overall tool performance. For process the needed equipment addition, form with tool measuring parameter. With comparing the results of trials using the tools developed in this study, namely the DS18B20 temperature sensor with an SNI thermometer, a pH sensor with a pH meter and TDS sensor with SNI TDS meter, then the accuracy value will be obtained from the reading of each sensors.

Equality A give How percent error can counted, whereas Equality B give calculation for accuracy values.

$$\% \text{ error} = \frac{|x - x_i|}{x} \times 100 \quad (\text{A})$$

$$\% \text{ accuracy} = 100\% - \% \text{ errors}$$

(B) Information :

x = mark Which obtained from tool measuring

Parameter x<sub>i</sub> = value Which obtained from sensors



Picture 15. Tools Image meter

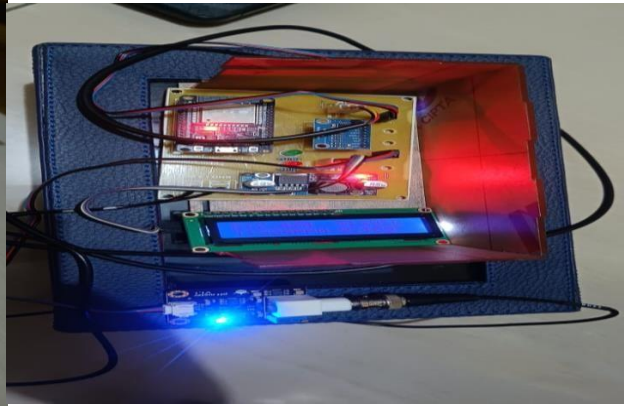

16. sensors pH, TDS And Temperature

### C. Testing Monitoring on the Blynk app



Figure 17. Appearance monitoring Application Blynk



Picture 18. Appearance information Mark on LCD

Displays the display of monitoring data that will be used in research. Systemwork according to the input given to the pH sensor used to measure degrees the acidity or alkalinity of the solution, the TDS sensor is used to measure dissolved particles in Water and Temperature Sensors DS18B20 is used to display temperature.

**D. Measurement Quality Water On waste water Treatment Plant Shifts 1 (Morning)**

Table 1. Results Data Measurement Quality Water on waste water treatment Plant Shifts 1 (Morning)

O'clock	pH Blynk	pH Meters	TDS (mg/L) Blynk	TDS (mg/L) Meters	Temperature (°C) Blynk	thermo(°C) Meters	Error%		
							pH	TDS (mg/L)	Temperature (°C)
08:00	7,67	7,68	984	985	29	29	0.130	0.101	0.000
10:00	7,32	7,32	996	996	29	29	0.000	0.000	0.000
12:00	6.85	6,87	982	982	31	31	0.291	0.000	0.000
14:00	6.97	6.97	998	999	30	30	0.000	0.100	0.000
Flat-flat	7,202	7,210	990	990.5	29,7	29,7	0.105	0.050	0.000

Table 2. Results accuracy Shifts 1( Morning )

No.	Parameter	Value Limit Maximum	Results accuracy Shifts Morning
1.	sensors pH	6 – 9 (ph )	99.895%
2.	sensors TDS	2000 ( mg/L )	99.95%
3.	sensors Temperature	25 – 32 ( °C )	100%

Results from Table 1 And 2 know that comparison results measuring on shifts 1 (Morning), error values and accuracy values, values obtained from sensors using measuring instruments Standard No different Far. Measurement use sensors pH with pH meters has a difference that is not too big, namely for the pH sensor on Blynk the average value 7.202 and a pH meter of 7.210. The average value of the percentage error at pH is 0.105% and level mark accuracy 99.895%. Then measurement from sensors TDS And TDS meters has not too much difference, namely for the TDS sensor on Blynk the average value 990 ppm and a TDS meter of 990.5 ppm. The average value of the percentage error on TDS is 0.050% and an accuracy rate of 99.95%. Then measurements from the temperature sensor and Thermometer has the same average value of 29.7°C. Percentage average value error on temperature 0.000% and the level of accuracy 100%.

#### E. Measurement Quality Water On waste water Treatment Plant Shifts 2 (Afternoon)

Table 3. Results Data Measurement Quality Water on Wastes water treatment Plant Shifts 2 (Afternoon)

O'clock	pH Blynk	pH Meters	TDS ( mg/L ) Blynk	TDS ( mg/L ) Meters	Temp eratur e( °C ) Blynk	thermo ( °C ) Meters	Error		
							pH	TDS ( mg/L )	Temp eratur e( °C )
16:00	7,23	7,25	982	982	29.5	29	0.276	0.000	1,666
18:00	7,70	7,70	998	999	29.5	29	0.000	0.100	0.000
20:00	7.65	7,66	1004	1005	29.5	29	0.130	0.099	0.000
10:00 p.m	7.35	7.35	1002	1002	28.5	29	0.000	0.000	1,724
Flat- flat	7,482	7,490	996.5	997	29,2	29	0.101	0.049	0.847

Table 4. Results Shift Accuracy 2 (Afternoon)

No.	Parameter	Value Limit Maximum	Results accuracy Shifts Afternoon
1.	sensors pH	6 – 9 ( pH )	99.899%
2.	sensors TDS	2000 ( mg/L )	99.951%
3.	sensors Temperature	25 – 32 ( °C )	99.153%

Results from Table 3 And 4 know that comparison results measuring on shifts 2 (afternoon), the error value and accuracy value, the value obtained from the sensor using a measuring instrument Standard No different Far. Measurement use sensors pH with pH meters has a difference that is not too big, namely for the pH sensor on Blynk the average value 7.482 and pH meter 7.490. The average value of the percentage error at pH is 0.101% and level of accuracy value of 99.899%. Then measurements from the TDS sensor and TDS meter own difference No too Far, that is For sensors TDS on Blynk mark average 996.5 ppm and the TDS meter is 997 ppm. The average value of the percentage error on TDS is 0.049% and an accuracy rate of 99.951%. Then measurements from the temperature sensor and The Thermo Meter has a not too big difference, namely for the temperature sensor on Blynkthe average value is 29.2°C and the thermometer is 29°C . The average value of the percentage error at temperature 0.847% and the level of accuracy is 99.153%.

**F. Measurement Quality Water On waste water Treatment Plant Shifts 3 (Evening)**

Table 5. Data on the results of water quality measurements at the Waste Water Treatment Plant Shift 3 (Evening)

O'clock	pH Blynk	pH Meters	TDS (mg/L) Blynk	TDS (mg/L) Meters	Temp eratur e(°C) Blynk	Temp eratur e(°C) Meters	Error		
							pH	TDS (mg/L)	Temp eratur e(°C)
00:00	7,43	7,43	984	984	29	29	0.000	0.000	0.000
02:00	7,53	7,55	1005	1005	28	28	0.265	0.000	0.000
04:00	7,65	7,65	996	998	28	28	0.000	0.200	0.000
06:00	7,78	7,79	978	979	29	29	0.128	0.102	0.000
Flat-flat	7,597	7,605	990.7	991.5	28.5	28.5	0.393	0.075	0.000

Table 6. Accuracy Results Shifts 3 ( Evening )

No.	Parameter	Limit Mark Maximum	Results accuracy Shifts Evening
1.	sensors pH	6 – 9 (ph )	99.607%
2.	sensors TDS	2000 ( mg/L )	99.925%
3.	sensors Temperature	25 – 32 ( °C )	100%

The results from Tables 5 and 6 know that the comparison of measurement results in shift 3 (Malam), error values and accuracy values, values obtained from sensors using tools Standard measurements do not differ much. Measurement using a pH sensor with a pH meter own difference No too big, that is For sensors pH on Blynk mark average 7.597 and pH meter 7.605. The average value of the percentage error at pH is 0.393% and level of accuracy value of 99.607%. Then measurements from the TDS sensor and

TDS meter has not too much difference, namely for the TDS sensor on Blynk the average value 990.7 ppm and the TDS meter is 991.5 ppm. The average value of the percentage error on TDS is 0.075% and an accuracy rate of 99.925%. Then measurements from the temperature sensor and Thermometer has the same average value of 28.5°C. Percentage average value error on temperature 0.000% and value level accuracy 100%.

Table 7. Accuracy Result Throughout Shift

No.	Parameter	Value Limit Maximum	Results accuracy Shifts Morning	Results accuracy Shifts Afternoon	Results accuracy Shifts Evening
1.	sensors pH	6 – 9 (ph )	99.895%	99.899%	99.607%
2.	sensors TDS	2000 ( mg/L )	99.95%	99.951%	99.925%
3.	sensors Temperature	25 – 32 ( °C )	100%	99.153%	100%

### G. Conclusion and Suggestion

#### 1) Conclusion

Based on the research and trial stages of the monitoring system design pH quality of water in the Industrial Area of PT. SEER on Waste Water Treatment Plant use method study, development And use Flow chart as method For planning with use Language Programming C on Arduino, then it can be concluded as follows: a water quality monitoring system monitoring quality pH, Water temperature and TDS quality To measure particles dissolved in water And monitoring quality pH water on waste water treatment Plant updates in real time from near and far with Internet technology of things with utilise Blynk as interfaces monitoring on smartphones.

#### 2) Suggestion

In developing a monitoring system for water pH quality in industrial estates PT.SIER researchers provide advice to related parties based on problem Which happened, among other things as follows :

- A. To improve the water quality monitoring system develop tools advanced with involve more Lots Again parameter, No only just parameter pH, Temperature, TDS (Total Dissolved Solid )
- B. So tool function with Good needed network stable And strong, so there is no delivery of data on the results of monitoring the quality of pH, temperature and TDS problem

## H. References

- Arif .W., Nurhayati Nur. K., (2020). "System Monitoring Quality Water On System Aquaponics based Iots". *Technique Electro*, 10.
- Asmara, R. K. P (2020). Design Get up Tool Monitoring And Handling Quality Ait On Fish Aquarium ornamental Internet based Of Things (IOT). *JournalTechnique Electrical And Computer TRIAC* , 7 (2), 69-74.
- Baringbing, Rahel M. *System Monitoring Quality Water Use sensors pH And sensors TDS based android* . Diss. Sumatra University North, 2020.
- Chuzaini, fanharis, and Dzulkiflih Dzulkiflih. "IoT MONITORING QUALITY WATERWITH USE TEMPERATURE SENSOR, pH, AND TOTAL DISSOLVED SOLIDS (TDS)." *Innovation Physics Indonesia* 11.3 (2022): 46-56.
- Dewi, Lestari Rozita, et al. "Design of Monitoring Tools for TDS, Water Temperature and Ph With Use microcontrollers arduino Mega." *Proceedings of Science And Technology* 2.1 (2023): 570-576.
- Hafidhudin. Notosudjono.D., Fiddiansyah.D.B., "Prototype System Automation Installation Processing Wastewater (WWTP) And Monitoring kindly Realtime based Microcontroller", Vol 1, No 1, 2018.
- Himawan, Frandi, Pressa Perdana, and Yoedo Ageng Surya. "Design of Smart Garden Prototypes Using Cameras, Soil Temperature and Humidity Sensors Based on the Internet of Things (IOT) with ESP8266." *JEETech Journal* 2.2 (2021): 78-83.
- Khasanah, Umroh Tul, et al. "Design of Water Quality Measuring Instruments Using Method Store With Temperature Parameters, pH, Turbidity and TDS." *INOVTEK- Series Electrical* 3.2 (2021): 62-71.
- Lintang.E., Firdaus., Nurcahyani. I., (2017). "System Monitoring Quality Water On Pool Fish Based Wireless sensors network Use CommunicationZigbees.", 2017.
- Maulani.K., Tenang.S., Hilman.N.A., "Prototype of PH Control System Based Microcontroller Arduino With Visualization Visual Basic On Finals waste water Treatment.", 2019.
- Qalit. A., Fardian., Rahman. A., "Design Build a Prototype Monitoring Rate pH And Control Temperature As well as Giving Feed Automatic on Cultivation Fish Catfish Sangkuriang based IoT." Vol.2, No.3, 2017.
- Rahayuningtyas, A., Sagita, D., Susanti, N. D., & West, J. (2021). System detection Andmonitoring water quality in aquaponics based on android the detection and monitoring system of water quality in the aquaponic based on android. 15(1) .75–89.
- Samsudin.S.I, Salim. S.I.M, Osman. K., Sulaiman.S.F, Sabri. M.I.A, "A Smart Monitoring of a water Quality detectors System ", Vol. 10, No. 3, 2018.
- Surya, Pressa Perdana, and Rini Puji Astutik. MOUSETRAP MONITORING AND CONTROL SYSTEM WITH AUTOMATIC FEEDER BASED ON ANDROID MOBILE. *Power Electronics: Journal of Electro People* 11.1 (2022): 26-30.
- Tumimomor, F., Paliling, S., & pungus, M. (2020). Effect of Filtration To Mark pH, TDS, conductance And Temperature Water Laundry Waste. *charms Science:Journal Physics Education* , 1 (1), 1-9.
- Ula, Dewi Alfiyatul. *Design and build a water quality monitoring system suitable for consumption based on the internet of things with the Fuzzy Tsukamoto method as a system supporters decision* . Diss. Islamic University Country Maulana Malik Ibrahim, 2020.

Wirman, R. P., Wardhana, I., & Isnaini, V. A (2019). Study Level accuracy sensorson Design Build Tools Measuring Total Dissolved Solids (TDS) and Level Turbidity Water. *Journal of Physics*, 9(1), 37–46.